

СВЕТОДИОДЫ МОЩНЫЕ

ARPL-5W-GES

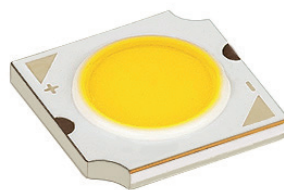

ОСОБЕННОСТИ

Features

- More energy efficient than incandescent and most halogen lamps.
- Low voltage operation.
- Instant light.
- Long operating life.
- Anti UV.

ПРИМЕНЕНИЕ

Applications

- Indoor lighting, spot light, ceiling light bulb.
- Architectural and landscape, lighting down light, wall lamp, garden light.
- Display lighting.

КОНСТРУКТИВНЫЙ ЧЕРТЕЖ

Package Dimensions

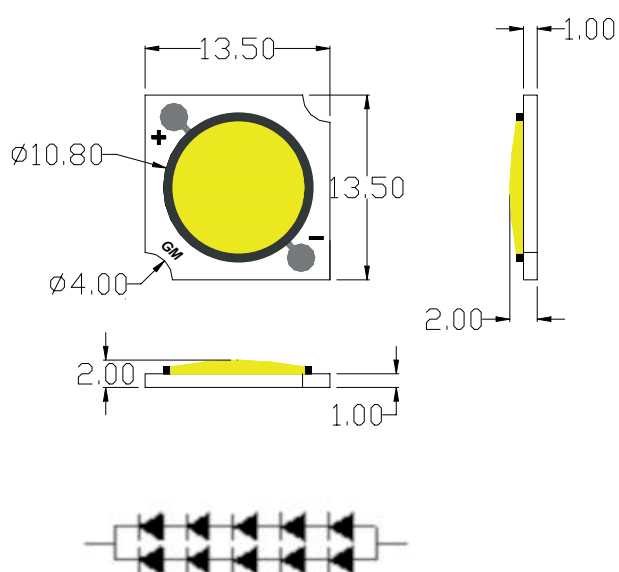

Notes: All dimensions in mm tolerance is ± 0.1 mm unless otherwise noted.

ПАРАМЕТРЫ

Technical specifications

Артикул Part number	018463
Модель Model	ARPL-5W-GES-1313-WW (320mA)
Цвет свечения Color	 Белый теплый

Absolute Maximum Ratings

Parameter	Symbol	Rating	Unit
DC Forward Current	I_F	400	mA
Peak pulse Current*	I_{FP}	600	mA
Reverse Voltage	V_R	25	V
Power Dissipation	P_D	7	W
Operating Temperature Range	T_{OPR}	-30~+75	°C
Storage Temperature Range	T_{STG}	-40~+85	°C
LED Junction Temperature	T_J	125	°C

Notes 1. 1/10 Duty Cycle 0.1ms Pulse Width.

Electrical / Optical

Characteristics-White (At $T_A=25^\circ\text{C}$)

Parameter	Symbol	Conditions	Min	Typ	Max	Units
Forward Voltage	V_F	$I_F=320\text{mA}$	15.00	-	17.00	V
Thermal Resistance Junction To Board	$R\theta_{J-B}$	$I_F=320\text{mA}$	-	2	-	°C/W
Luminous Flux	Φ_V	$I_F=320\text{mA}$	450	-	550	Lm
Color Temperature	CCT	$I_F=320\text{mA}$	3000	-	3200	K
CRI	Ra	$I_F=320\text{mA}$	60	-	65	-
Temperature Coefficient of Forward Voltage	$\Delta V_F / \Delta T$	$I_F=320\text{mA}$	-	-2	-	mV/°C
Reverse Current	I_R	$V_R=25\text{V}$	-	-	10	μA
Viewing Angle ^[1]	$2\theta_{1/2}$	$I_F=320\text{mA}$	-	120	-	Deg

ЦВЕТОВАЯ ТЕМПЕРАТУРА

Color & binning

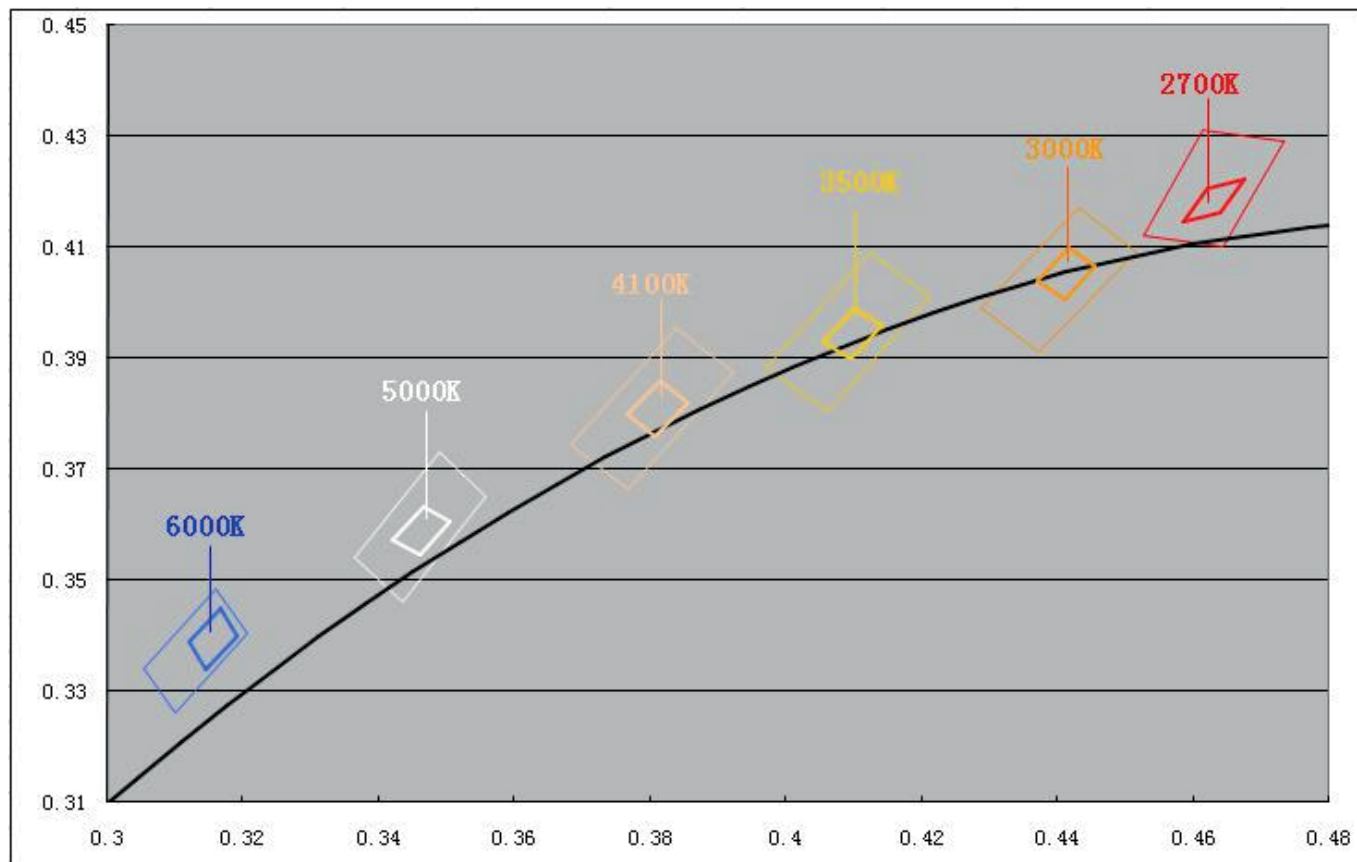

	0.4614	0.431		0.4432	0.4171		0.4122	0.409
2700	0.4732	0.429	3000	0.4516	0.4091	3500	0.421	0.401
	0.4643	0.41		0.4372	0.391		0.406	0.3805
	0.4525	0.412		0.4288	0.399		0.3972	0.3885
	0.3837	0.3954		0.3488	0.3732		0.316	0.3485
4100	0.3921	0.3874	5000	0.3558	0.3652	6500	0.3205	0.3405
	0.3766	0.3665		0.3434	0.3462		0.3099	0.326
	0.3682	0.3745		0.3364	0.3542		0.3054	0.334

ФОТОМЕТРИЯ

Typical Optical/Electrical Characteristics Curves

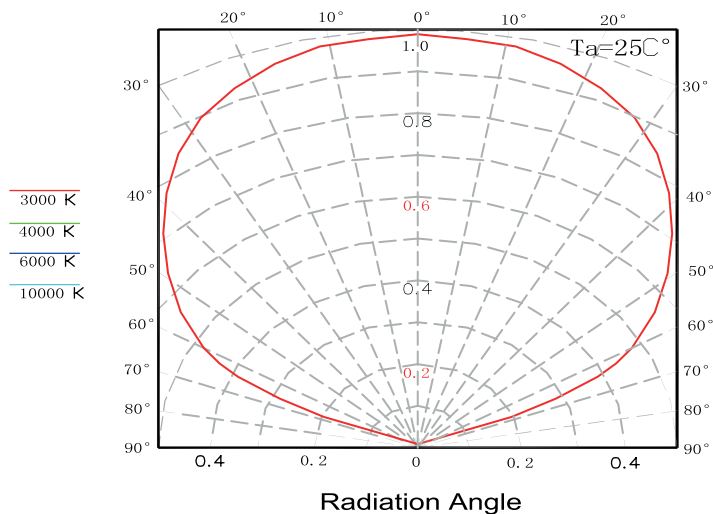
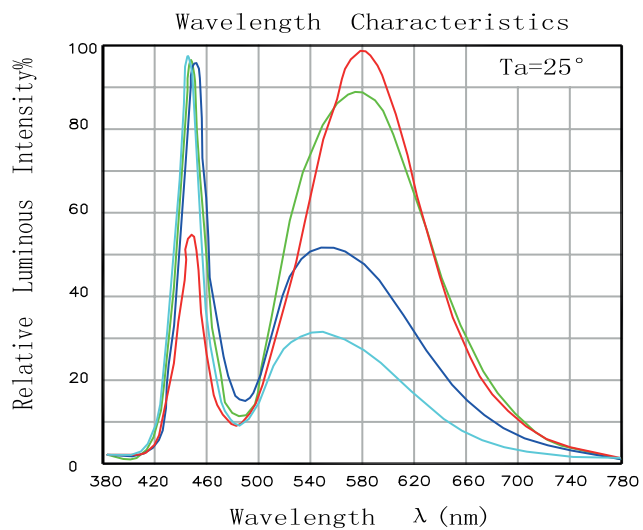
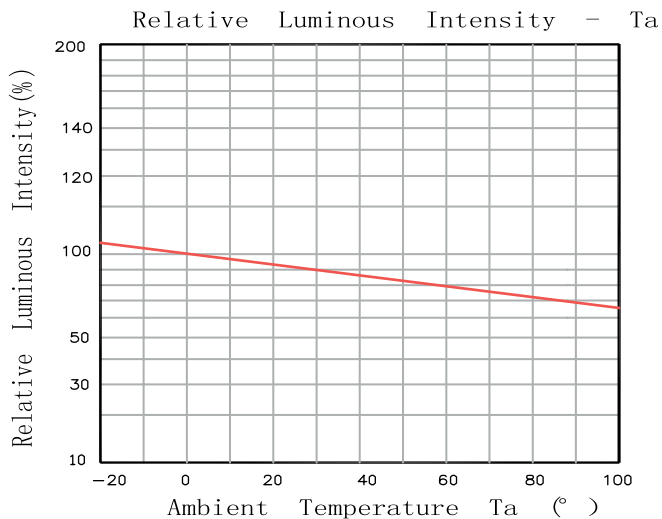
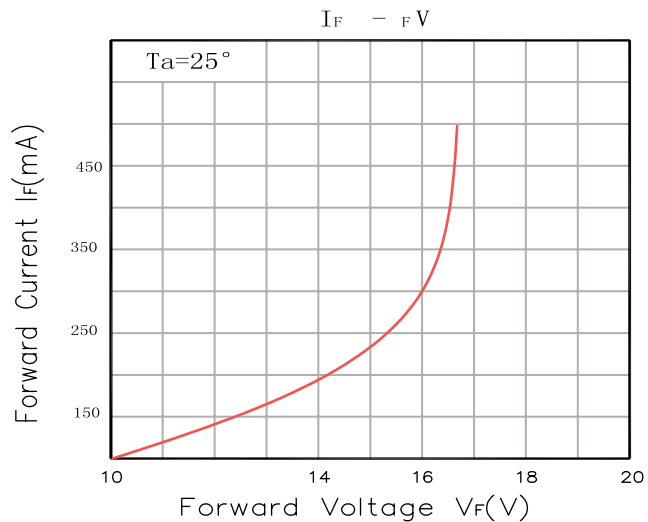
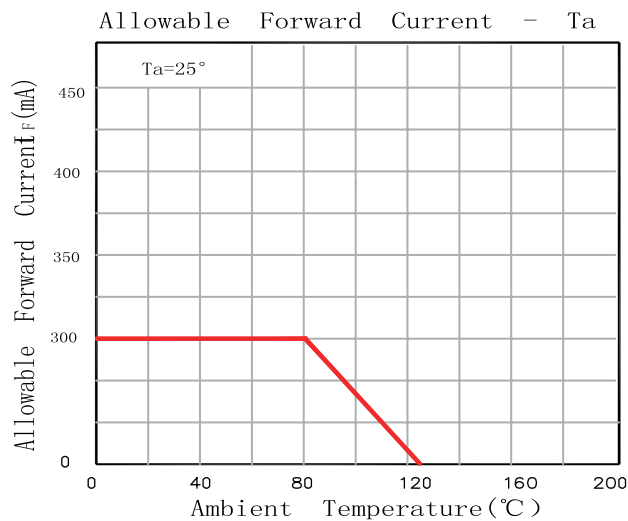
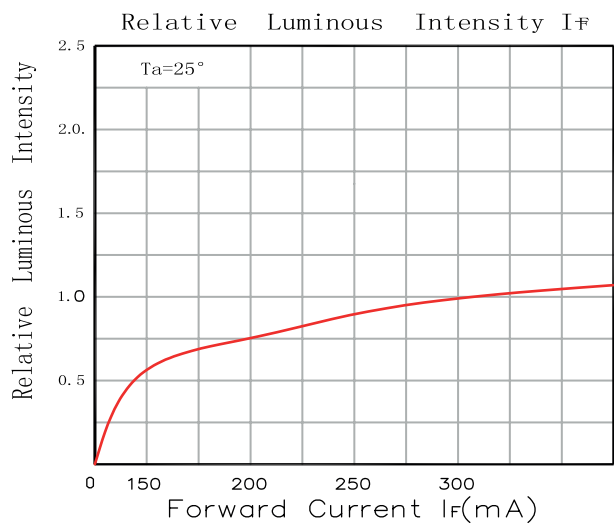

ТЕСТ НА НАДЕЖНОСТЬ

Reliability test standards

Test Item	REF. Standard	Test condition	Duration	Sample count	Accept
Temperature Cycle	JESD22-A104-A	-40 °C~25 °C~100 °C~25 °C 30min, 5min, 30min, 5min	100 cycles	22	0/22
Thermal shock	JESD22-A106	-40 °C ~100 °C 30min, 30min	100 cycles	22	0/22
High Temperature Storage	JEITA ED-4701 200 201	TA=100 °C±5 °C	1000 Hrs	22	0/22
Low Temperature Storage	JEITA ED-4701 200 202	TA=-40 °C±5 °C	1000 Hrs	22	0/22
Humidity Heat Storage	JIS C 7021 (1977)B-11	Ta=60 °C RH=85%	1000Hrs	22	0/22
Life test	JESD22-A108-A	Ta=25 °C If=300mA	1000Hrs	22	0/22
High humidity Heat life test	JESD22-A101	Ta=60 °C RH=85% If=300mA	1000Hrs	22	0/22
Resistance to soldering Heat	JESD22-A113	IR soldering 245 °C/10sec	1 time	22	0/22

МЕРЫ ПРЕДОСТОРОЖНОСТИ

Precautions for use

1. Storage

- The best Storage environment, temperature: 5°C~30°C. Humidity: 40% -80%HR.
- LED store after six months to be re-spectral color separation, to prevent the LED optical properties change.

2. Production and application:

- Need wear gloves when contact with led to prevent oxidation.
- ESD protection to be good.
- Soldering: can use soldering iron, the best temperature is 300°C / 3sec.
- Must have a good heat sinking, the temperature of the heat sink must be below 65 degree.
- When use please remove protective blue film.